



# Geländepläne



# 2024





Start- Aufwärmstrecke, 1000m,T1,  
2000m,3000m, Ziel  
Aufwärmstrecke = 3760m

**Vet Check**

Ottenheim  
Aufwärmstrecke

KI.A



Start- Aufwärmstrecke, 1000m,  
2000m, T1, 3000m,4000m, 5000m,  
Ziel  
Aufwärmstrecke = 5200m

**Vet Check**

Ottenheim  
Aufwärmstrecke

Kl. S

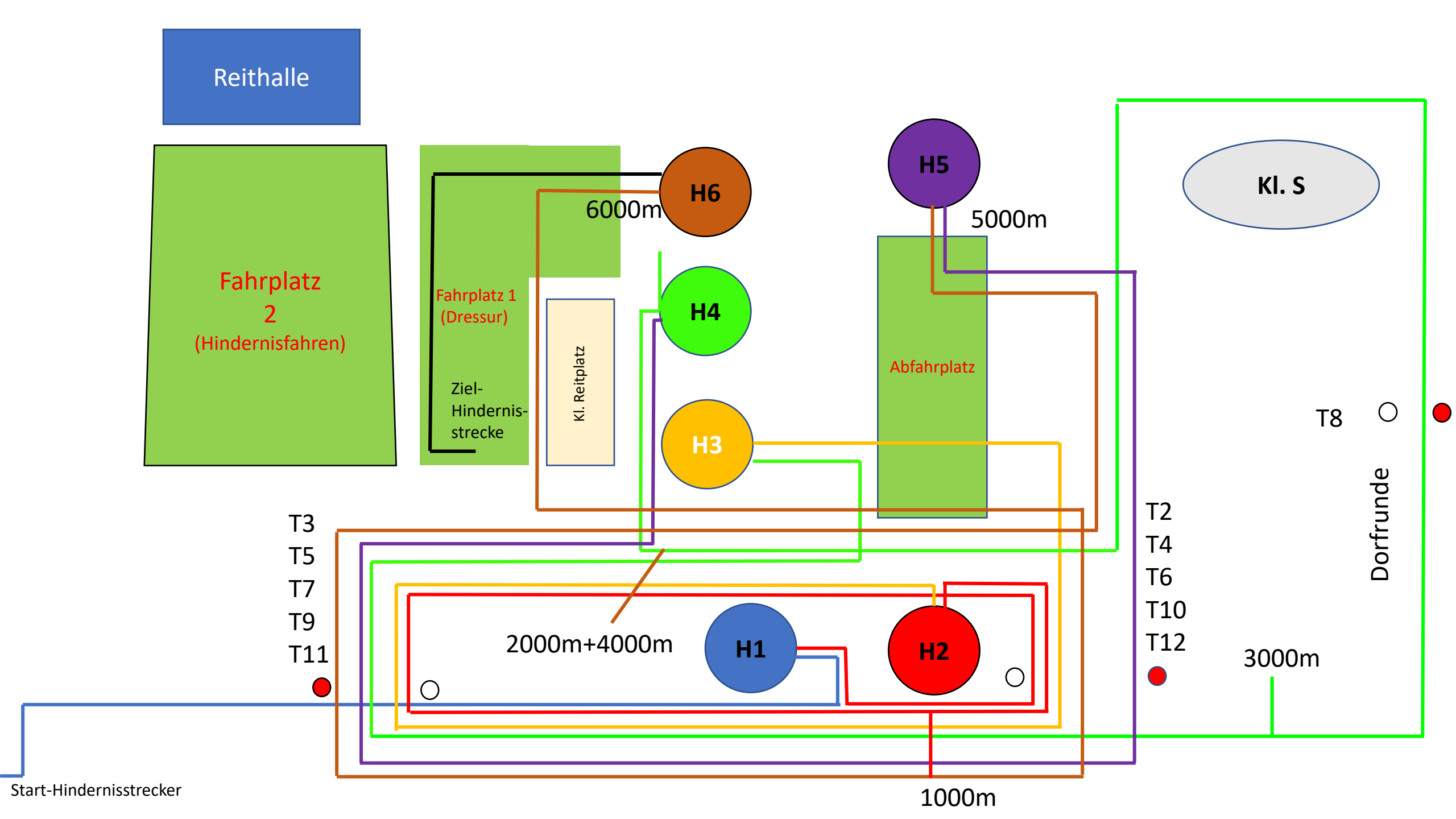

# Baden- Württembergische Meisterschaft 2024

## Reit- u. Fahrverein Ottenheim e.V.

Reithalle

Kl. A

Fahrplatz 2  
2  
(Hindernisfahren)

Fahrplatz 1  
(Dressur)

Ziel-  
Hindernis-  
strecke

Kl. Reitplatz

H4

H3

Abfahrplatz

3000m

2000m

T3

T5

T7



T2

T4

T6



H1

H2

1000m

Start-Hindernisstrecke

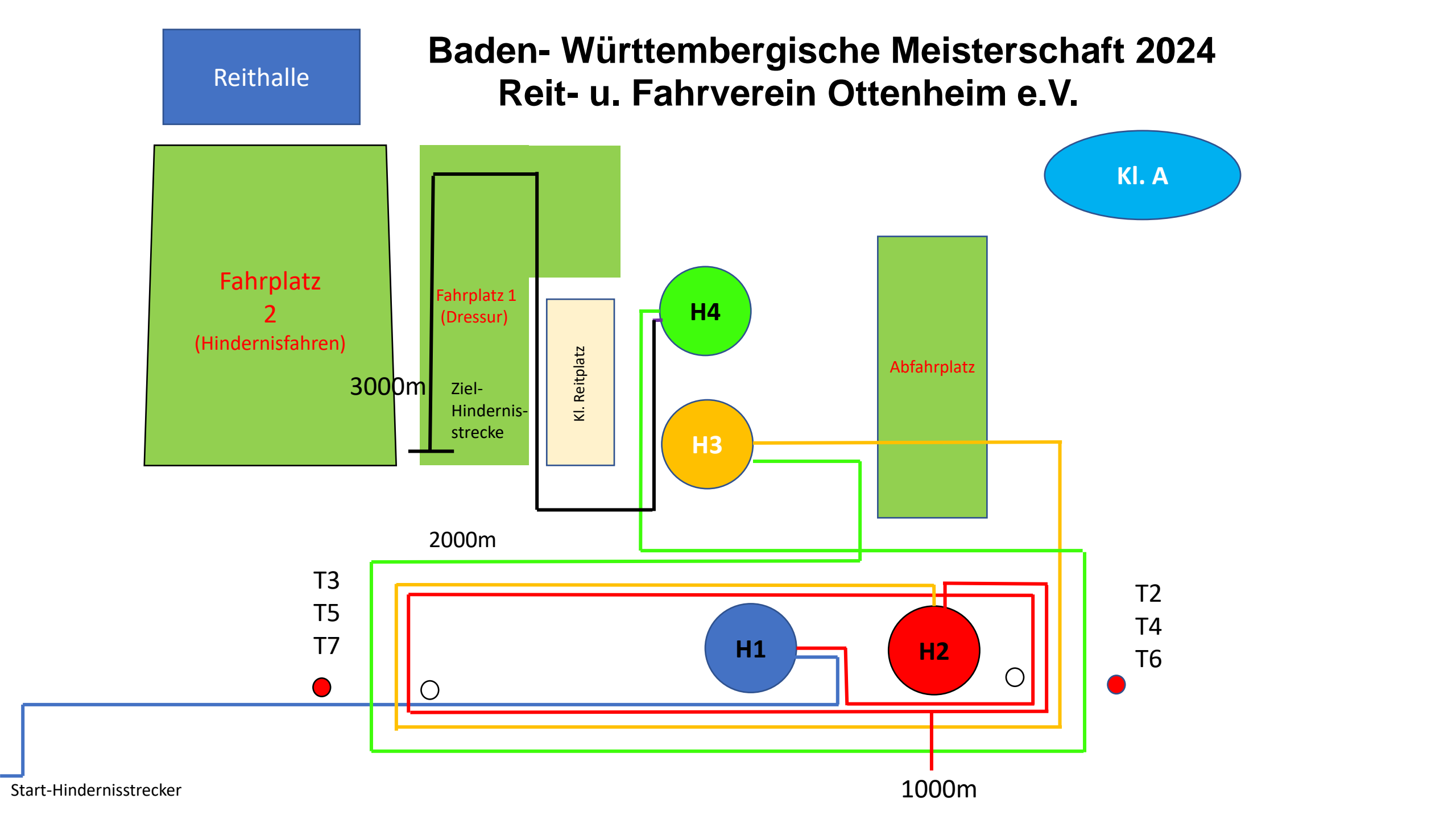



**Beden Württembergische**  
**Meisterschaft**  
**Ottenheim 2024**

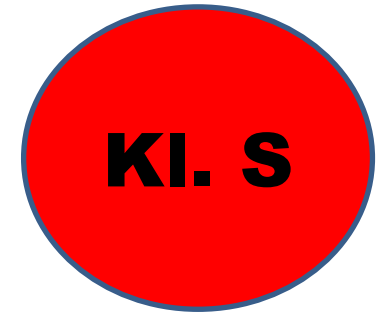

**Zeiten Marathon**

Pferde Kl. S	Länge Meter	Tempo Km/h	EZ <u>Min: sec</u> <small>Streckenlänge (Km) x 60 Tempo in Km/h</small>	BZ <u>Min: sec</u> <small>EZ - 2 Min</small>	HZ <u>Min: sec.</u> <small>EZ + 20%</small>	Pflicht Tore
Aufwärm- strecke	5200	13	24:00	22:00	26: 24	T1

Pferde Kl. S	Länge Meter	Tempo Km/h	EZ <u>Min: sec</u> <small>Streckenlänge (Km) x 60 Tempo in Km/h</small>	BZ <u>Min: sec</u> <small>EZ - 3 Min</small>	HZ <u>Min: sec.</u> <small>Doppelte EZ</small>	Pflicht Tore
Hindernis strecke	6250	14	26:47	23:47	53:34	T2-T12

<b>Hindernis strecke</b>	<b>Start-Hindernisstrecke, H1, T2, T3, 1000m, T4, H2, T5, T6, H3, 2000m, T7, 3000m, T8, 4000m, H4, T9,T10, H5, 5000m,T11, T12, 6000m, H6, Ziel.</b>
------------------------------	---



**Beden Württembergische**  
**Meisterschaft**  
**Ottenheim 2024**

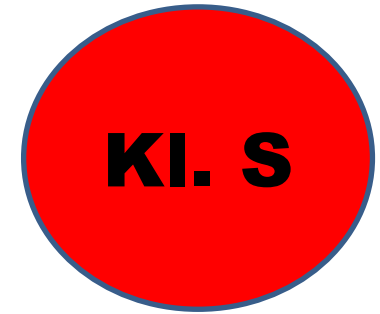

**Zeiten Marathon**

Pony KI. S	Länge Meter	Tempo Km/h	EZ <u>Min: sec</u> <u>Streckenlänge (Km) x 60</u> <u>Tempo in Km/h</u>	BZ <u>Min: sec</u> <u>EZ - 2 Min</u>	HZ <u>Min: sec.</u> <u>EZ + 20%</u>	Pflicht Tore
Aufwärm- strecke	5200	12	26:00	24:00	31: 12	T1

Pony KI. S	Länge Meter	Tempo Km/h	EZ <u>Min: sec</u> <u>Streckenlänge (Km) x 60</u> <u>Tempo in Km/h</u>	BZ <u>Min: sec</u> <u>EZ - 3 Min</u>	HZ <u>Min: sec.</u> <u>Doppelte EZ</u>	Pflicht Tore
Hindernis strecke	6250	13	28:50	25:50	57:40	T2-T12

Hindernis strecke	Start-Hindernisstrecke, H1, T2, T3, 1000m, T4, H2, T5, T6, H3, 2000m, T7, 3000m, T8, 4000m, H4, T9, T10, H5, 5000m, T11, T12, 6000m, H6, Ziel.
----------------------	--



**Beden Württembergische  
Meisterschaft  
Ottenheim 2024**

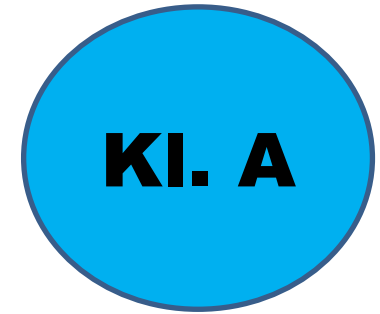

**Zeiten Marathon**

Pferde KI. A	Länge Meter	Tempo Km/h	EZ <u>Min: sec</u> <small>Streckenlänge (Km) x 60 Tempo in Km/h</small>	BZ <u>Min: sec</u> <small>EZ - 2 Min</small>	HZ <u>Min: sec.</u> <small>EZ + 20%</small>	Pflicht Tore
Aufwärm- strecke	3760	12	18:48	16:48	22:33	T1

Pferde KI. S	Länge Meter	Tempo Km/h	EZ <u>Min: sec</u> <small>Streckenlänge (Km) x 60 Tempo in Km/h</small>	BZ <u>Min: sec</u> <small>EZ - 3 Min</small>	HZ <u>Min: sec.</u> <small>Doppelte EZ</small>	Pflicht Tore
Hindernis- strecke	3020	13	13:56	10:56	27:52	T2-T7

Hindernis- strecke	Start-Hindernisstrecke, H1, T2, T3, 1000m, T4, H2, T5, T6, H3, 2000m, T7, H4, 3000m, Ziel.
-----------------------	--





**Beden Württembergische**  
**Meisterschaft**  
**Ottenheim 2024**

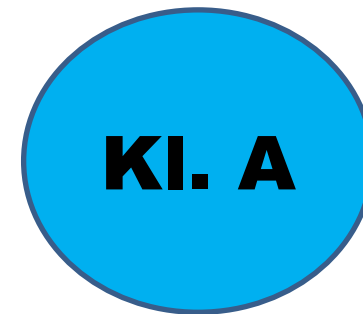

**Zeiten Marathon**

Pony KI. A	Länge Meter	Tempo Km/h	EZ <u>Min: sec</u> <small>Streckenlänge (Km) x 60 Tempo in Km/h</small>	BZ <u>Min: sec</u> <small>EZ - 2 Min</small>	HZ <u>Min: sec.</u> <small>EZ + 20%</small>	Pflicht Tore
Aufwärm- strecke	3760	11	20:30	18:30	24:36	T1

Pony KI. A	Länge Meter	Tempo Km/h	EZ <u>Min: sec</u> <small>Streckenlänge (Km) x 60 Tempo in Km/h</small>	BZ <u>Min: sec</u> <small>EZ - 3 Min</small>	HZ <u>Min: sec.</u> <small>Doppelte EZ</small>	Pflicht Tore
Hindernis strecke	3020	12	15:06	12:06	30:12	T2-T7

Hindernis strecke	Start-Hindernisstrecke, H1, T2, T3, 1000m, T4, H2, T5, T6, H3, 2000m, T7, H4, 3000m, Ziel.
----------------------	--

Klasse A  
A-D  
Klasse S  
A-F

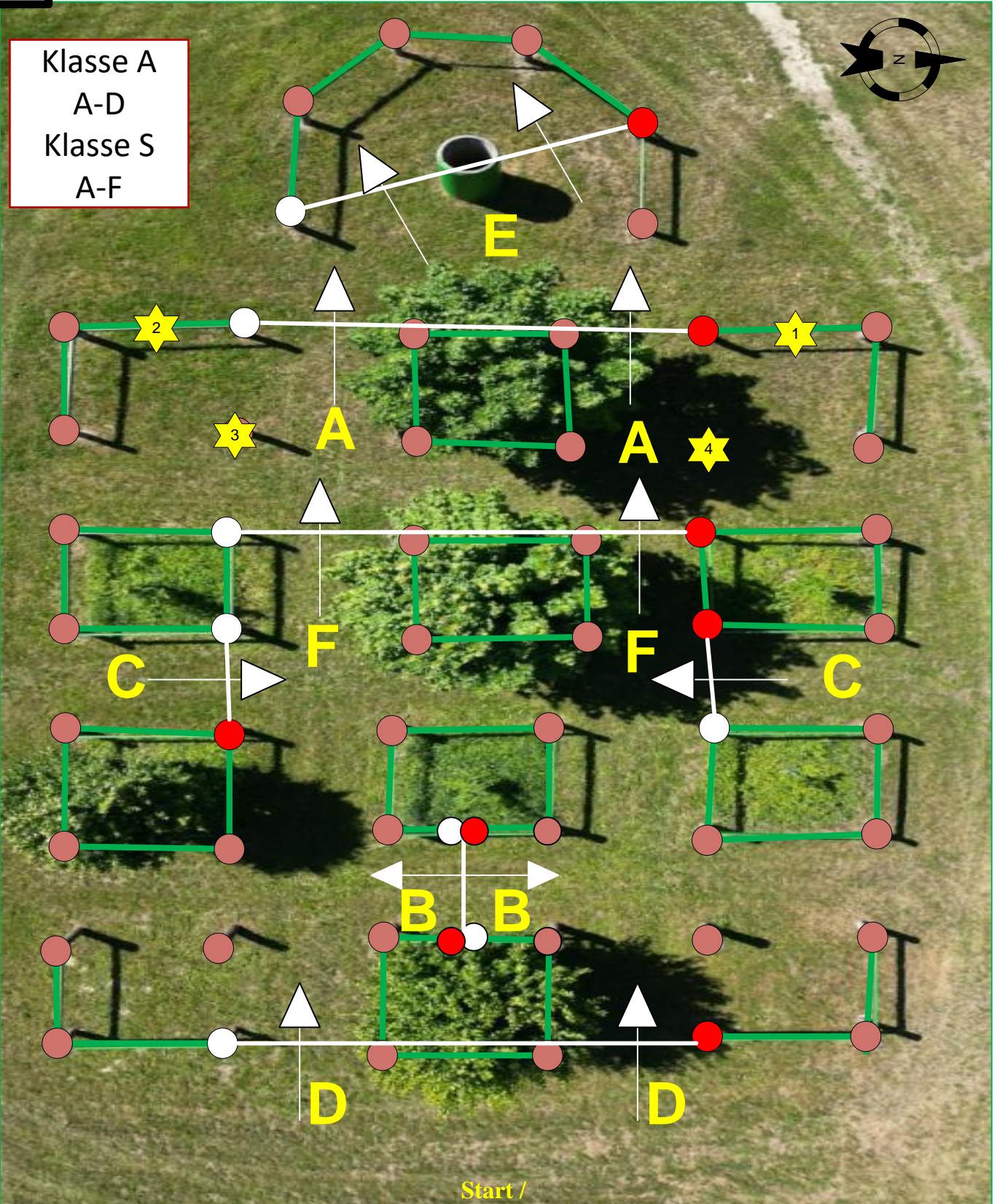

Abwerfbare  
Teile



H2

Start ↓ ↑ Ziel

Klasse A  
A-D  
Klasse S  
A-F

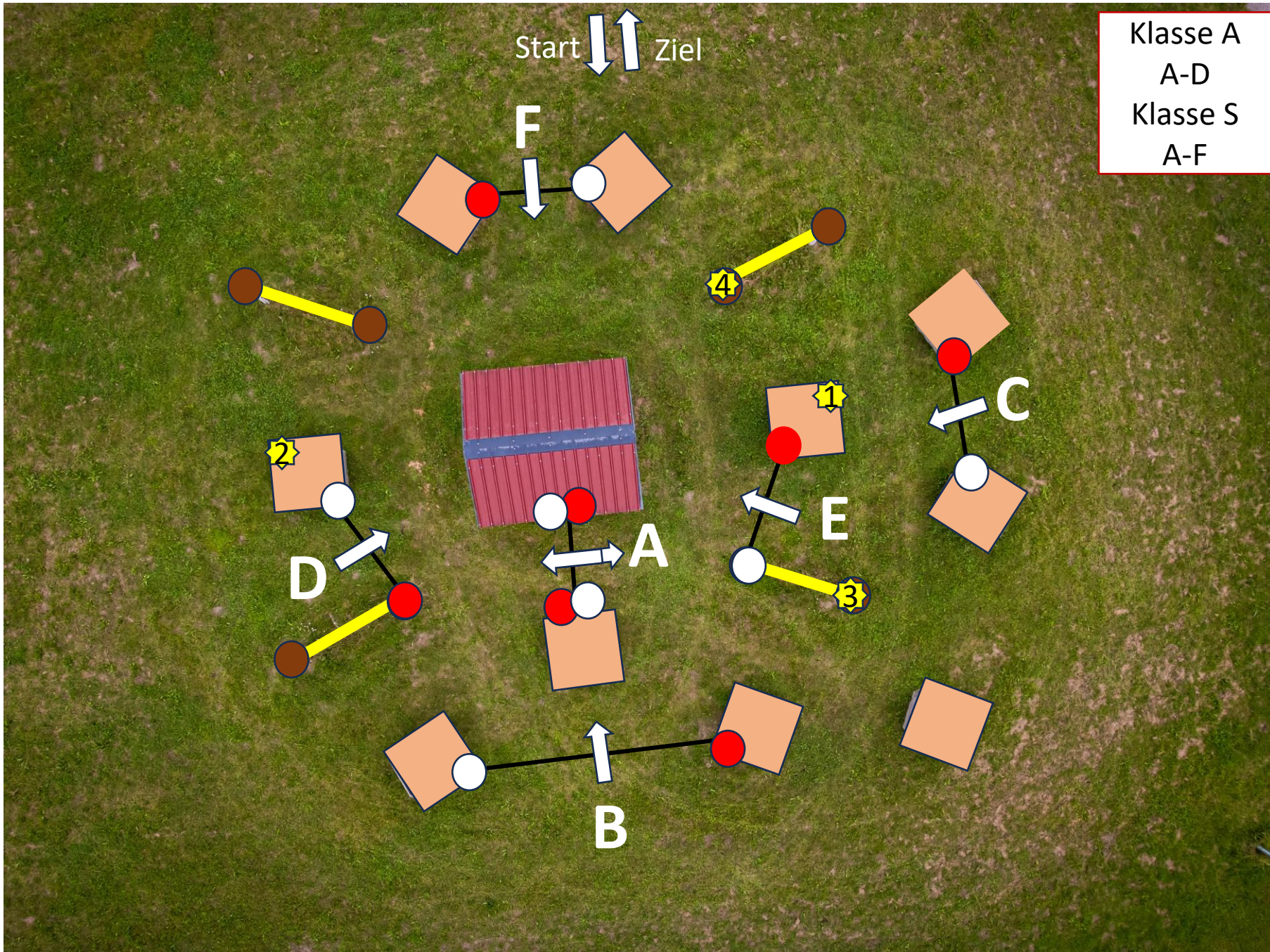

4 Abwerfbare  
Teile



Klasse A  
A-D  
Klasse S  
A-F

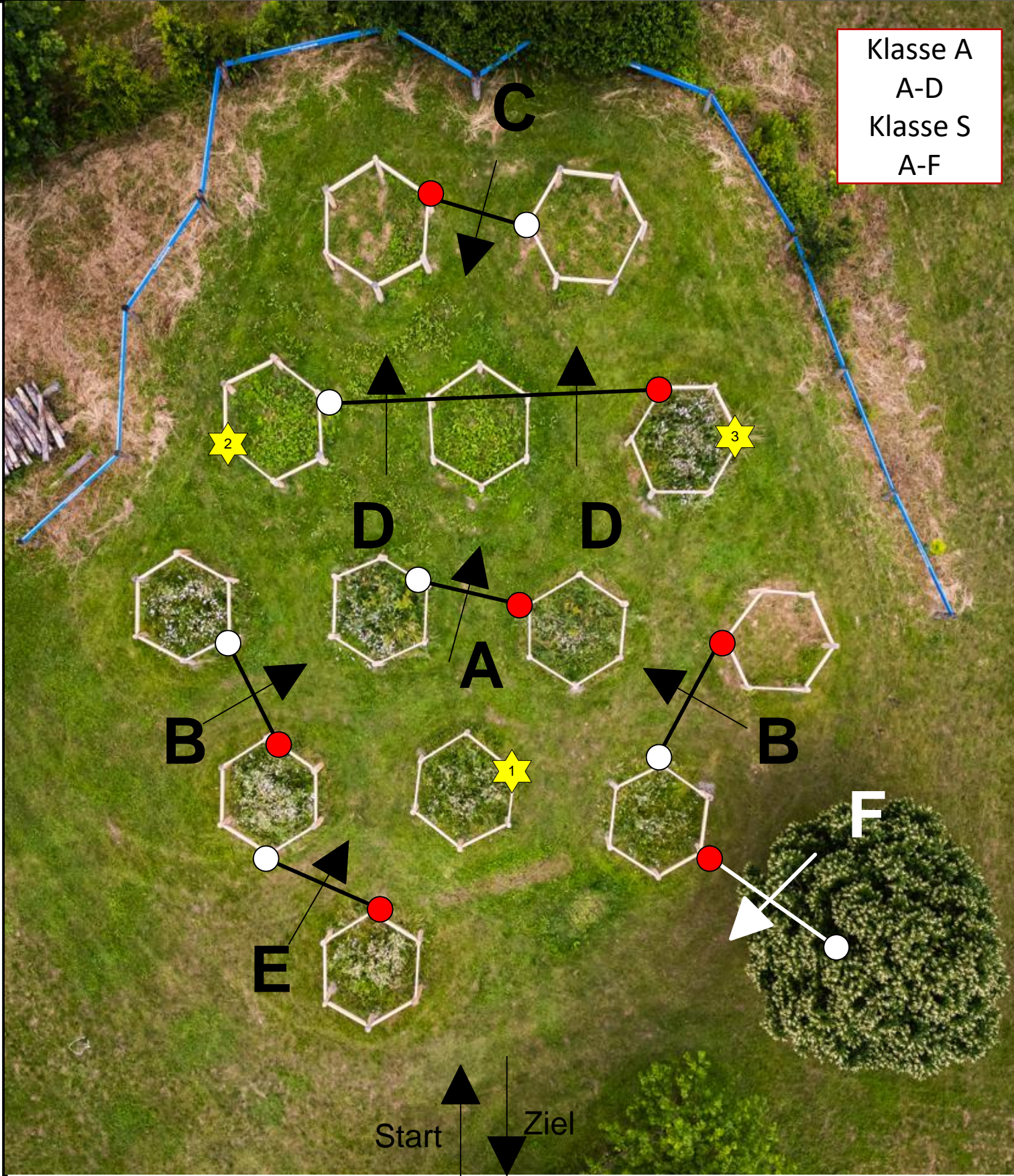

★ 3 Abwerfbare Teile

Start/  
Ziel

Klasse A  
A-D  
Klasse S  
A-F

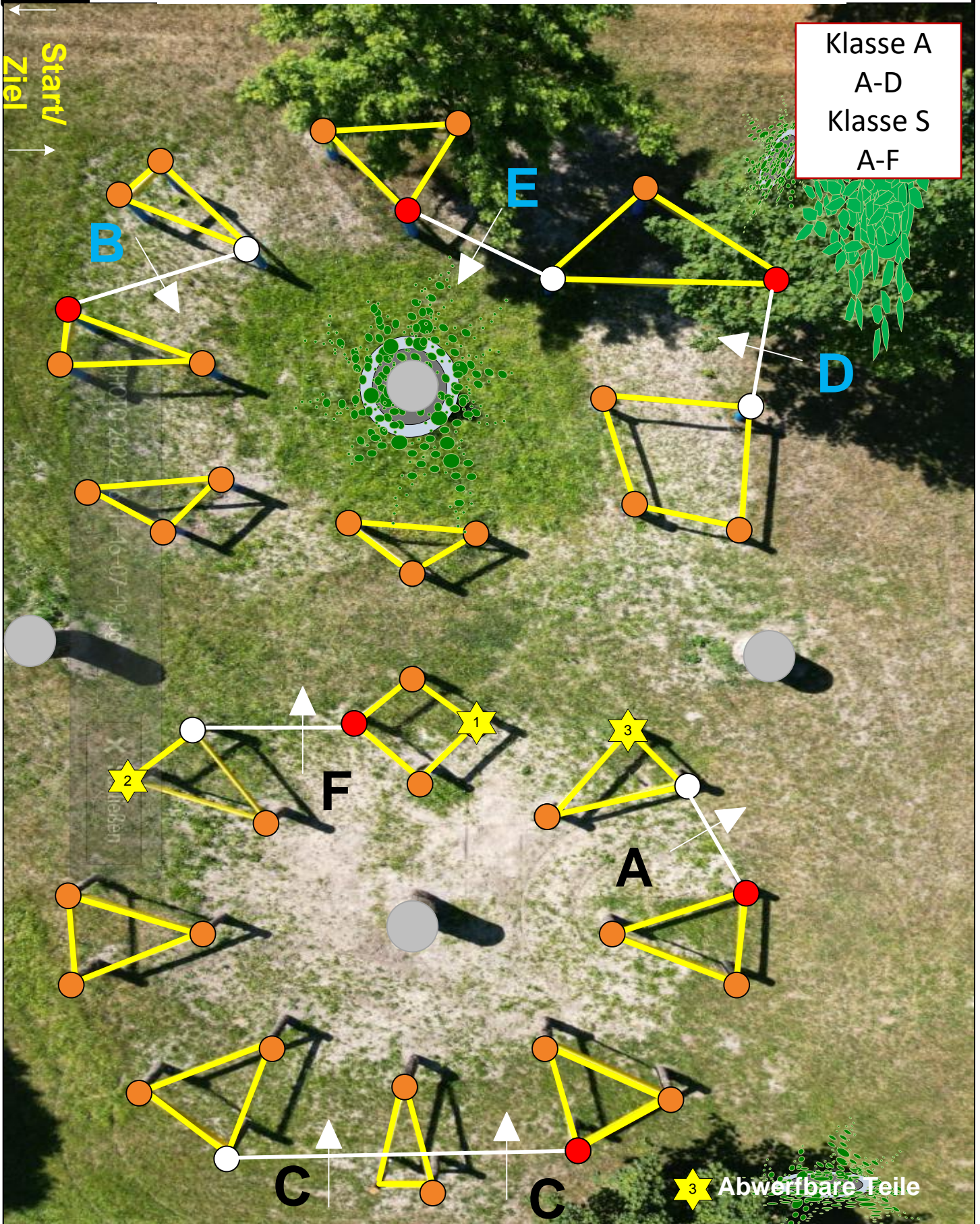

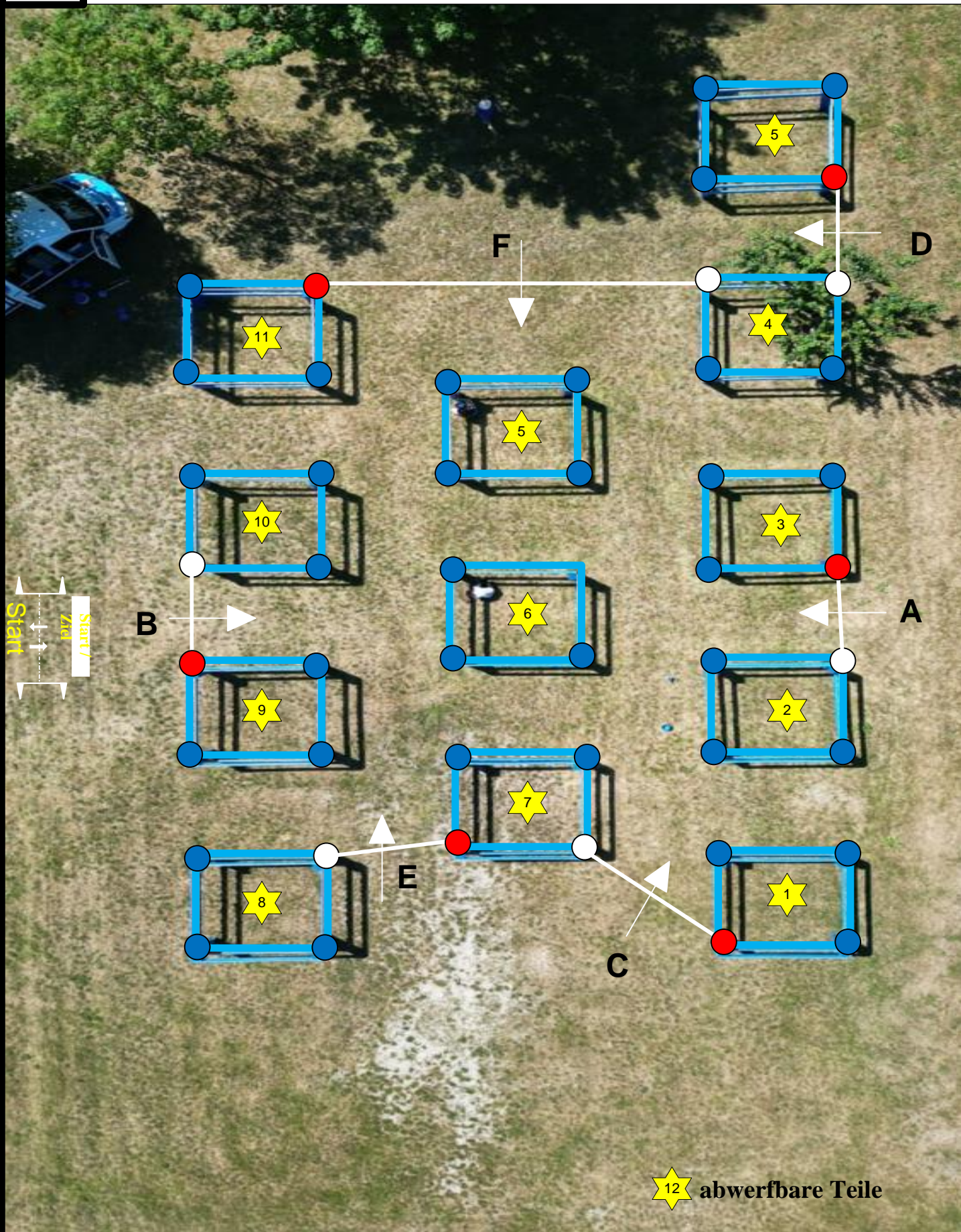

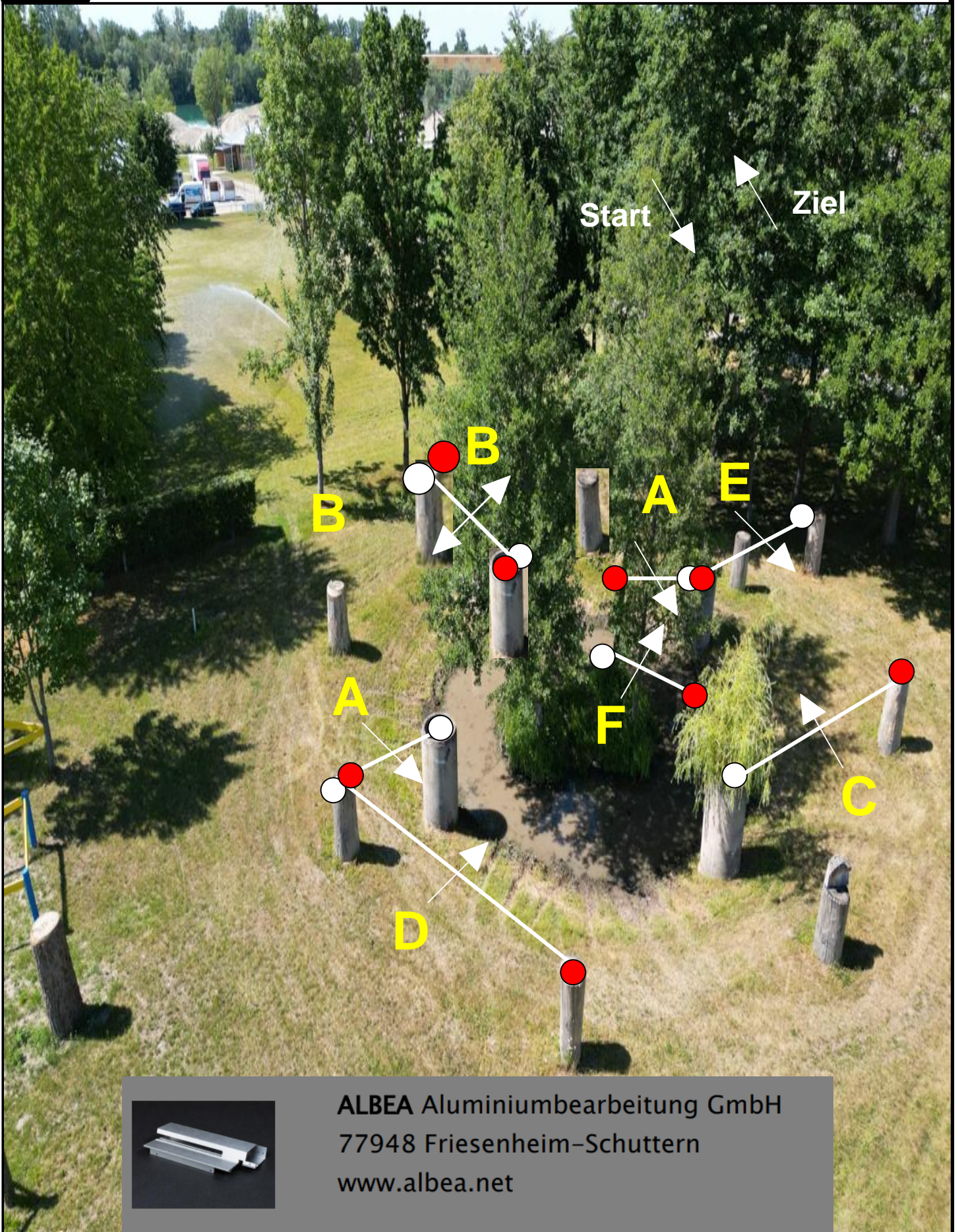

ALBEA Aluminiumbearbeitung GmbH  
77948 Friesenheim-Schuttern  
[www.albea.net](http://www.albea.net)